



Fixed-mounted
ROSA 3.x

Solar-powered
with RIO™ 360
and RIO™ 180

Switched
power with
ROSA-P 360

The multiple award-winning
ROSA™

Responsive Observation Security Agent
with available power and mounting options



ROSA™

Responsive Observation Security Agent

Smart, Autonomous Response, Deployable Just About Anywhere.

At the core of the **RAD ecosystem** is what's known as an **'autonomous response'**, the series of programmed and machine-learned responses to events and actions within the device's field of view. Other 'security devices' record video for later retrieval and review, but only after the occurrence of suspicious or unlawful activities. RAD devices can **detect and deter unwanted activities** like trespassing, loitering and vagrancy which often lead to more serious or costly crimes.

ROSA harnesses the immense power of RAD's AI analytic library to be able to detect when an unusual situation occurs and if it continues. These fully customizable autonomous responses could be an escalation of both audible and visual alerts, including highly visible lighting and blaring alarms. If the detected situation continues, ROSA may open lines of communication with local or remote monitoring personnel or law enforcement to dispatch additional resources to the scene.

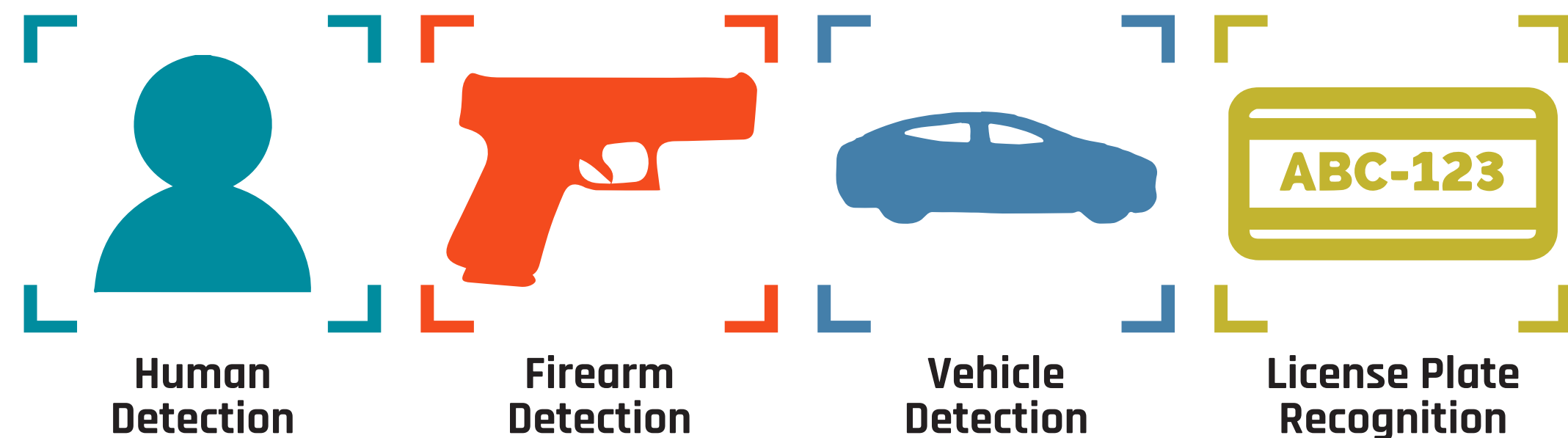

ROSA will autonomously react with customizable responses upon the detection of people, firearms, vehicles, license plates and more.



**99%+ Detection Reliability.
Fewest False Positives.**

Security Where and When You Need It.

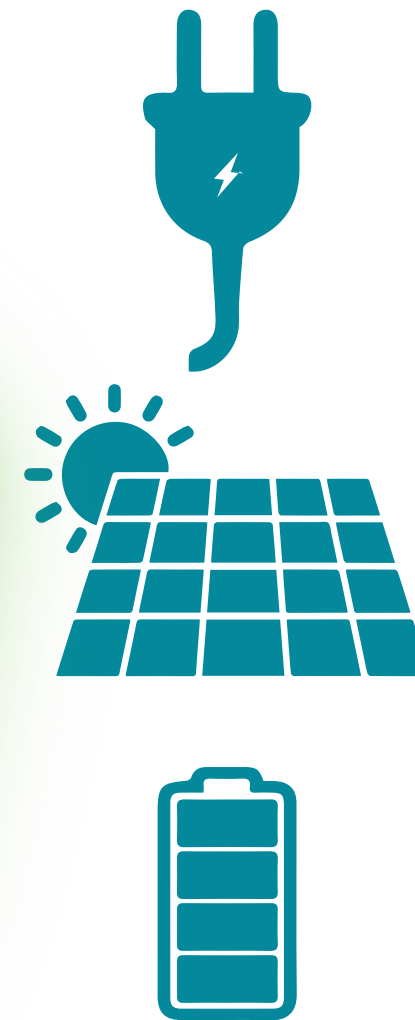

It's Plug and Play Security-in-a-Box

There's never been a more versatile or universal security device than RAD's ROSA. In just about 15 minutes, **ROSA** can be deployed, powered by standard 110VAC, solar power (**RIO 360 and RIO 180**), or 24/7 auxiliary battery power (**ROSA-P**). Connectivity with ROSA is even easier, regardless of where ROSA is deployed the device automatically connects to RAD's cloud-based servers via 'enhanced cellular' connectivity, meaning there's zero IT resources required to install and activate.

Stand back and observe as ROSA lights up, connects and then reports that it's "ready for service".

Part of Your Complete Security Solution

It has become more challenging to recruit and maintain a staff of quality security guards. Businesses are rushing to discover cost-effective alternatives to rising guard costs and declining guard performance.

RAD's sole mission, which ROSA enables, is to arm smart businesses with tomorrow's autonomous remote services and AI-powered tools – today.

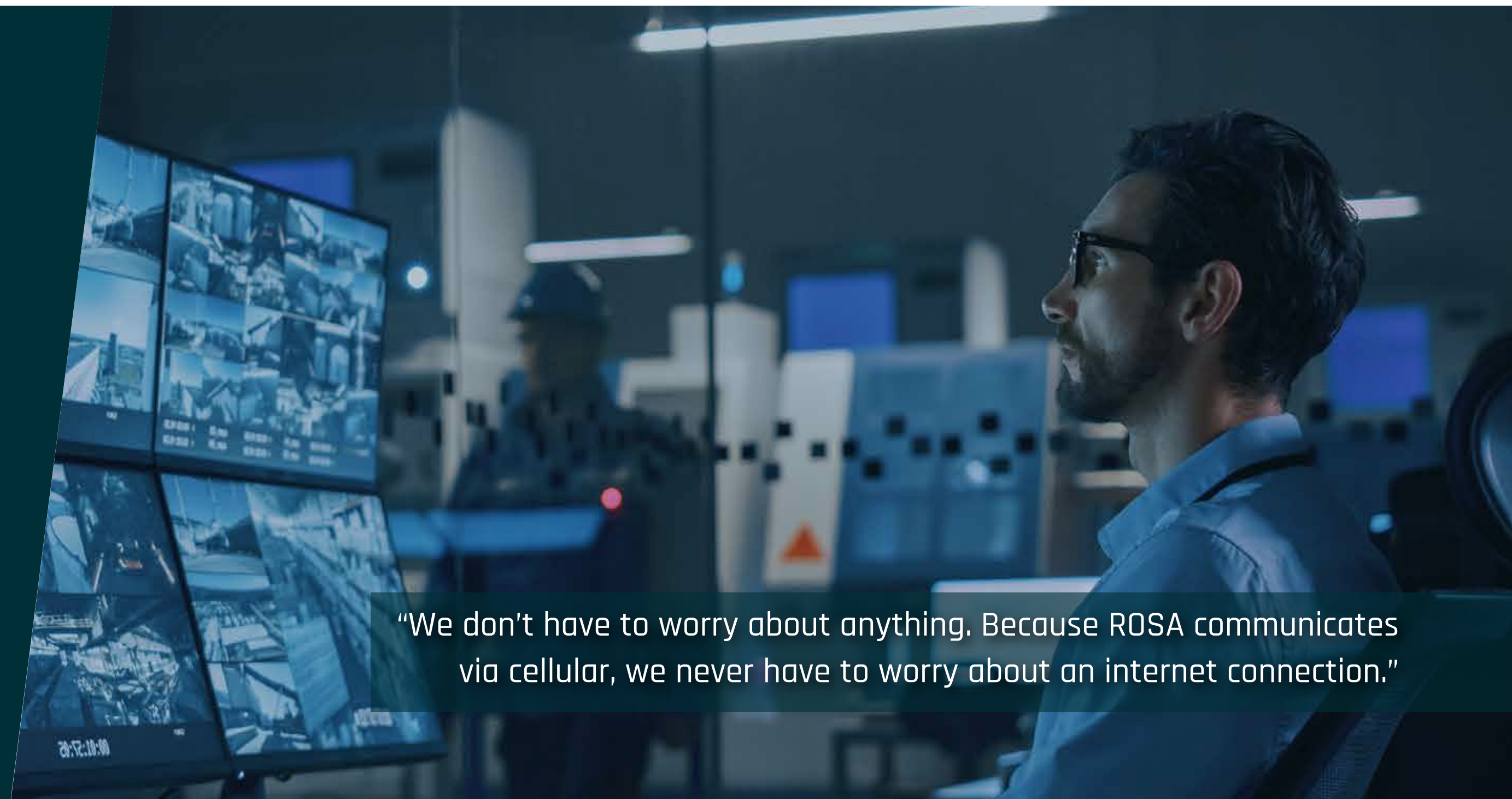

"We don't have to worry about anything. Because ROSA communicates via cellular, we never have to worry about an internet connection."

RIO™ 360

ROSA Independent Observatory

RIO makes portable security easy, fast, and affordable. RAD's technical team will install and deploy your RIO when and where you need that extra security and safety advantage. And best of all, the deployment possibilities with RIO are practically endless,

Sitting atop RIO is ROSA, the recipient of multiple industry awards and wide acclaim and for its ability to autonomously detect and deter instances of trespassing and other property intrusions without the need for manned guarding assistance. ROSA, now with the RIO Solar Tower will certainly continue its successes in the construction, property management, retail, critical infrastructure industries and more.

Every industry has things of value that are worth protecting, whether that's people, property, inventory, or equipment. No matter where you are and what you need secured, RIO, ROSA and RAD will be there to help you keep your facilities safe and secure.

Retail Parking Lots
Construction Sites
Utility & Infrastructure Properties
Entertainment & Sports Venues
School Campuses
Healthcare Facilities
Property & Real Estate Management
... and much more



RIO 360 with its tandem ROSA configuration protecting a commercial parking lot.

Shown with standard **tandem ROSA units** to achieve 360° field of view or to focus on specific points of interest. Can be positioned to achieve optimal visibility.



RIO™ 360

ROSA Independent Observatory

# of ROSA Units:	2
Field of View:	360°
# of Solar Panels:	4
Max. Height:	17.38' (5.30 m) Mast Extended
Min. Height:	8.03' (2.45 m) Mast Retracted
Max. Length:	16.42' (5.00 m) all Panels Extended
Min. Length:	11.04' (3.36 m) all Panels Retracted
Max. Width:	10.64' (3.24 m) 4 Legs Extended
Min. Width:	4.97' (1.51 m) 4 Legs Retracted
Total Weight:	~981 lb (~445 kg)
Wind Resistance:	~100 mph (~161 kph) Mast Retracted
Solar Panels:	48V 4S
Batteries:	48V 4P
Deployment:	One Person, Standard Pallet Jack
Notice:	Not DOT Approved for Road Travel
Warranty Service:	Included in Subscription

Communications

- High-speed 4G LTE cellular connectivity, no IT resources required
- Cellular plan included in subscription service
- LAN Wi-Fi connectivity option

Power System

- Battery powered
- Maintenance-free sealed batteries
- Solar-based charging system charges batteries and powers ROSA automatically without intervention
- Solar array tilts for optimal sun exposure
- Charging system shuts down when batteries are fully charged, preventing damage
- Can boost charge from vehicle, standard power or generator

Tamper Resistance

- Tamper-resistant battery compartment with tamper alarms

Details subject to change without notice.

RIO™ 180

ROSA Independent Observatory

# of ROSA Units:	1
Field of View:	180°
# of Solar Panels:	2
Max. Height:	17.38' (5.33 m) Mast Extended
Min. Height:	8.03' (2.45 m) Mast Retracted
Max. Length:	11.04' (3.36 m) Solar Panels Extended
Min. Length:	11.04' (3.36 m) Solar Panels Retracted
Max. Width:	10.64' (3.24 m) 4 Legs Extended
Min. Width:	4.97' (1.51 m) 4 Legs Retracted
Total Weight:	~833 lb (378 kg)
Wind Resistance:	~100 mph (~161 kph) Mast Retracted
Solar Panels:	48V 2S
Batteries:	48V 2P
Deployment:	One Person, Standard Pallet Jack
Notice:	Not DOT Approved for Road Travel
Warranty Service:	Included in Subscription

Shown with its **single ROSA units** to achieve 180° field of view or to focus on specific points of interest. Can be positioned to achieve optimal visibility.



ROSA-P 360

ROSA for Night-Switched Power Systems

ROSA-P 360 is designed to provide continuous surveillance, intrusion detection and deterrence, powered by an existing light pole whose power supply is controlled by a timer or a photocell. ROSA-P 360's power control unit draws power from the existing power supply and simultaneously charges its internal UPS battery banks. When the power stops flowing, ROSA-P 360 continues to stay online.

Universal Mounting

- The power enclosure is securely positioned on the ground or concrete foundation

Universal Power Support

- Supports 110, 220, 264, 277 and 480 VAC available power

Weather-Proof Enclosure

- Aluminum construction with durable, powder-coat finish

100% Self-Contained

- Batteries, power inverters and other equipment is protected from tampering

Warranty Service

- Included in subscription

Standard Configuration

- Standard with **Tandem ROSA units** to achieve a full 360° field of view

Specifications

Dimensions	840 × 308 × 1212 mm (33 × 12 × 48")
Mass	110 kg (242 lbs)
Line Voltage IN	120 / 207 / 240 VAC (1-phase); or 277 / 480 / 600 VAC (1-phase) with optional transformer
Line Power IN	1700 W
Battery Voltage	50.8 VDC (nom) 58 VDC (max)
Battery Capacity	3048 W·h each
Output Voltage	12 VDC (nom)
Output Current	27.5 A
Charge Time	4 hours
Run Time	40 hours (2 batteries)

Configurations

Transformer	WITH or WITHOUT
Batteries	TWO
ROSA	TANDEM



Shown with standard **tandem ROSA units** with a 360° field of view. Can be positioned to achieve optimal visibility.

ROSA-P 360
Power Enclosure

RAD Light My Way™

Peace of Mind, In the Palm of Your Hand

RAD Light My Way offers property managers a new and better way to address nighttime security on their properties. A first of its kind, the solution puts the power of security in the hands of employees, tenants, and visitors through the combination of affordable, smart, interactive technology, a mobile app, and live remote monitoring and response services.

The commercial real estate market has taken notice. RAD Light My Way is the winner of the 2021 Best Workplace Experience Award, part of CBRE's annual Supplier Innovation Challenge.

The foundation of the Light My Way solution is RAD's suite of artificial intelligence-driven security robotic devices. Each features a combination of high-resolution cameras, human and vehicle detection, license plate recognition, responsive digital signage and audio messaging, lights, sirens, and two-way communication with remote monitoring security personnel. Units are available in several form-factors: tower, wall-mounted panel, overhead device, and rugged, autonomous 4-wheeled rover. The devices have already proven effective at performing many of the same tasks as onsite human guards.

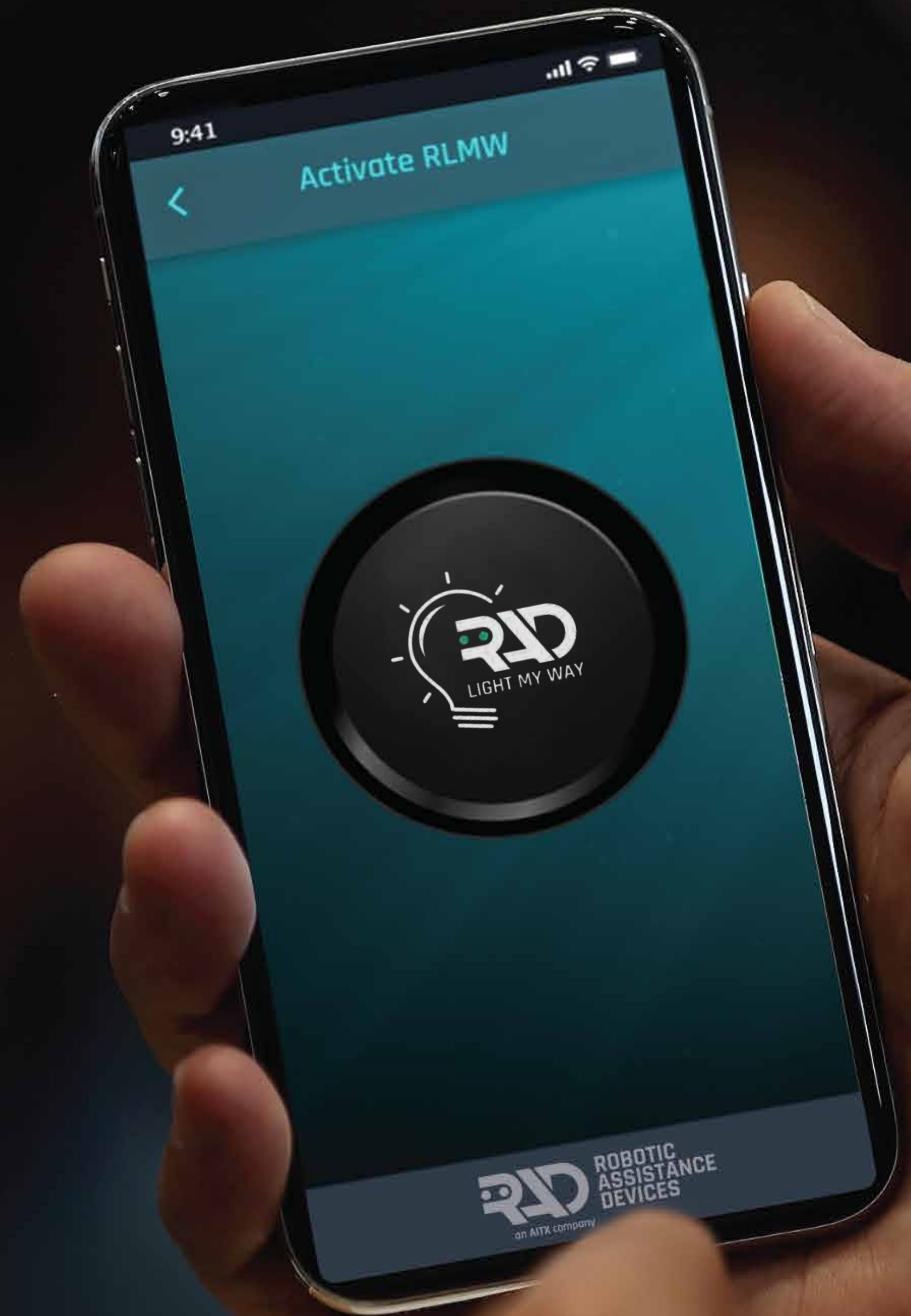

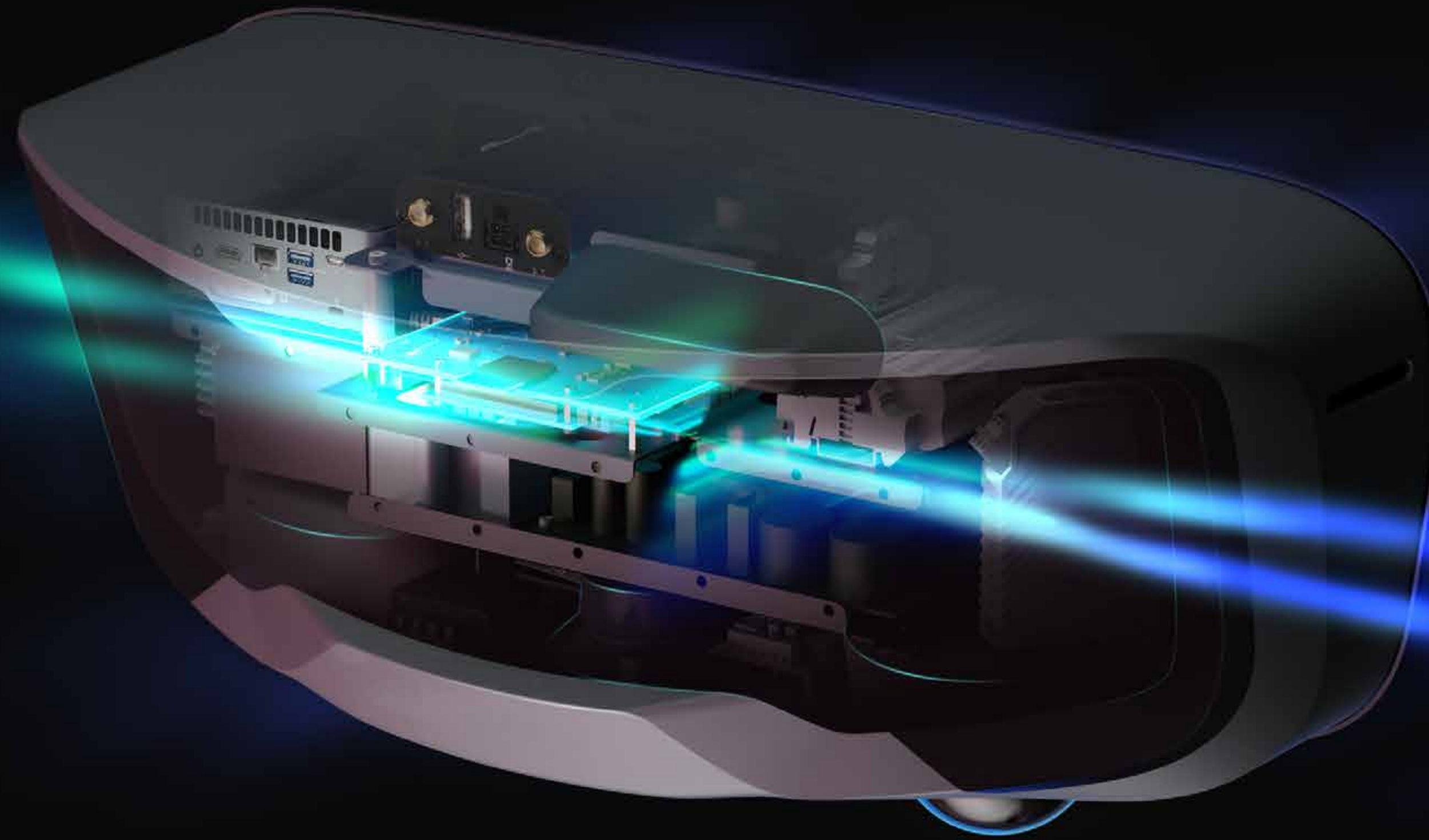

RADPack™ - Enabling Robust AI

RAD delivers a massive boost in performance with the new RADPack 'Compute & Control' hardware controller. Capable of handling even the most demanding AI analytics, RAD Pack powers every aspect of ROSA's real-time video, audio, autonomous response messaging and cellular-enhanced cloud communications.

Tucked inside ROSA's sleek design, and powered by RADPack, are (2) high resolution, full color, always-on digital cameras, (1) 2TB HDD server and drive, (1) 100W marine-rated audio speaker, and enough battery backup storage to power the device for hours in the event of a power outage.

"RADPack opens the door for robust functionality across the RAD product line with features that we have yet to conceive. It's really an entirely new platform for us to build upon. It's at the core of what I refer to as RAD 3.0, the next phase of RAD,"

- Steve Reinharz, Founder and CEO at RAD

ROSA Security-in-a-Box Components



ROSA 3.x Technical Specifications

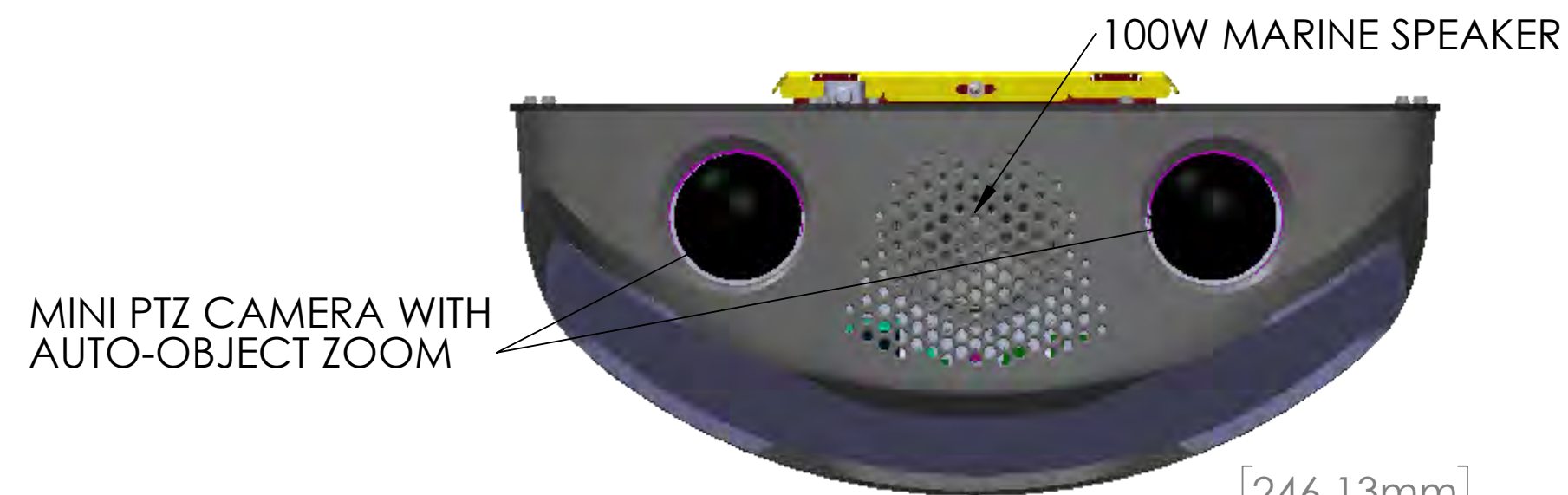
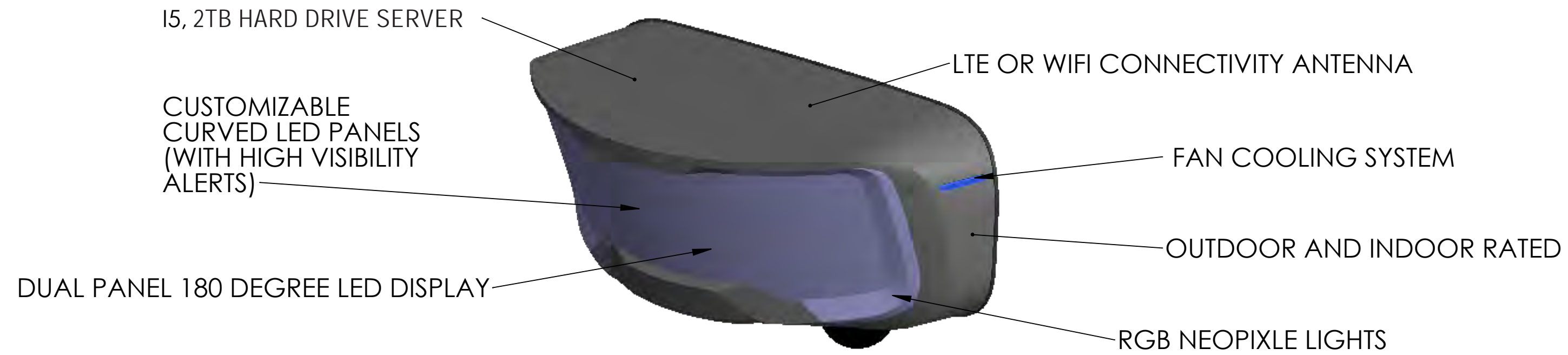

OVERALL WEIGHT: 30 LBS

WALL MOUNTING:

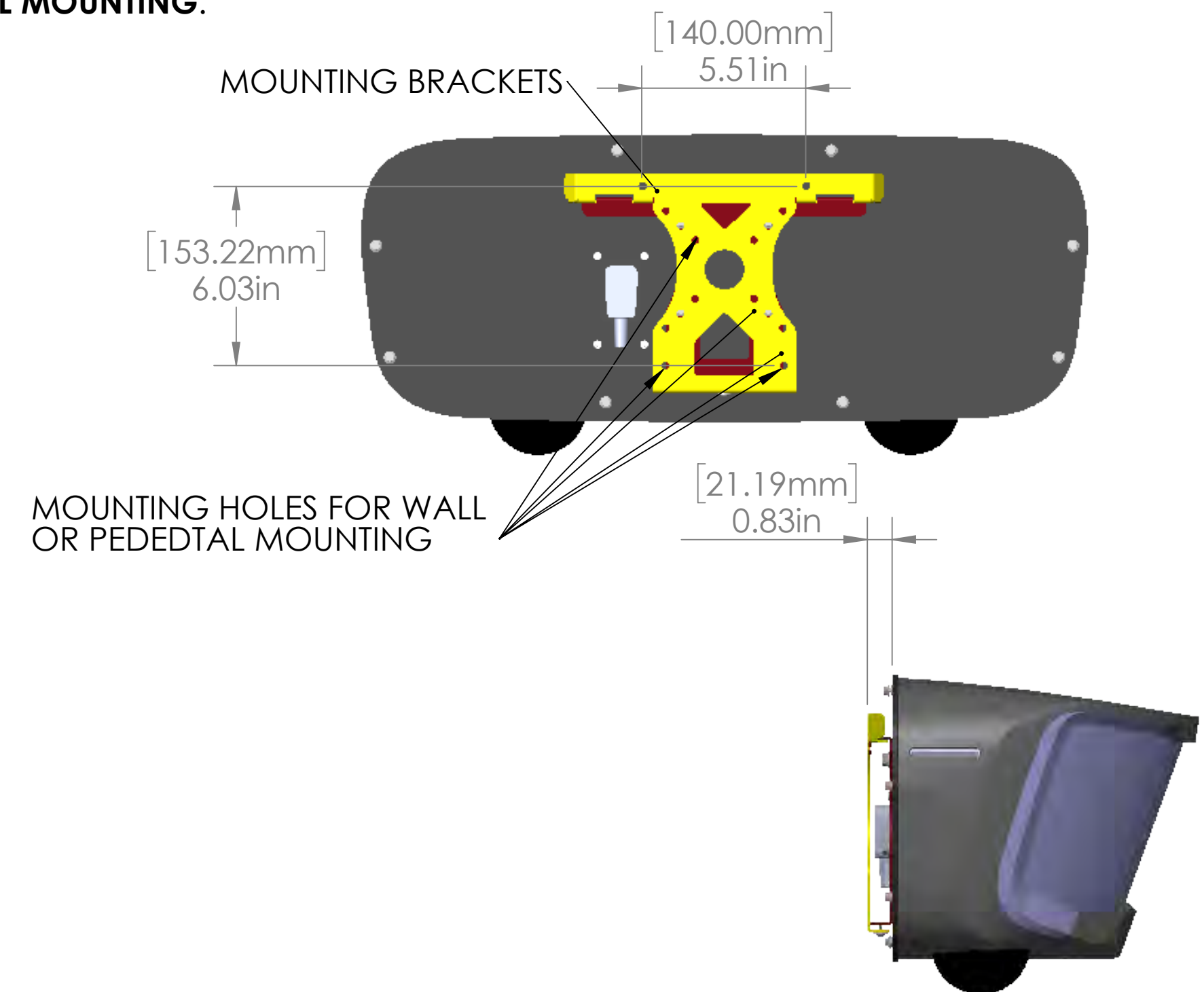

RADSoC - Data at Your Fingertips on Any Platform

real time
visibility

easy device
customization

mobile
alerts

metrics

incident data
analysis and
management

easily initiate
audio 'talk down'
through RAD device

customize
autonomous
response escalation

note: RAD device subscriptions include an unlimited number of user licenses to all software applications

Incident Management - Now Part of RADSoC

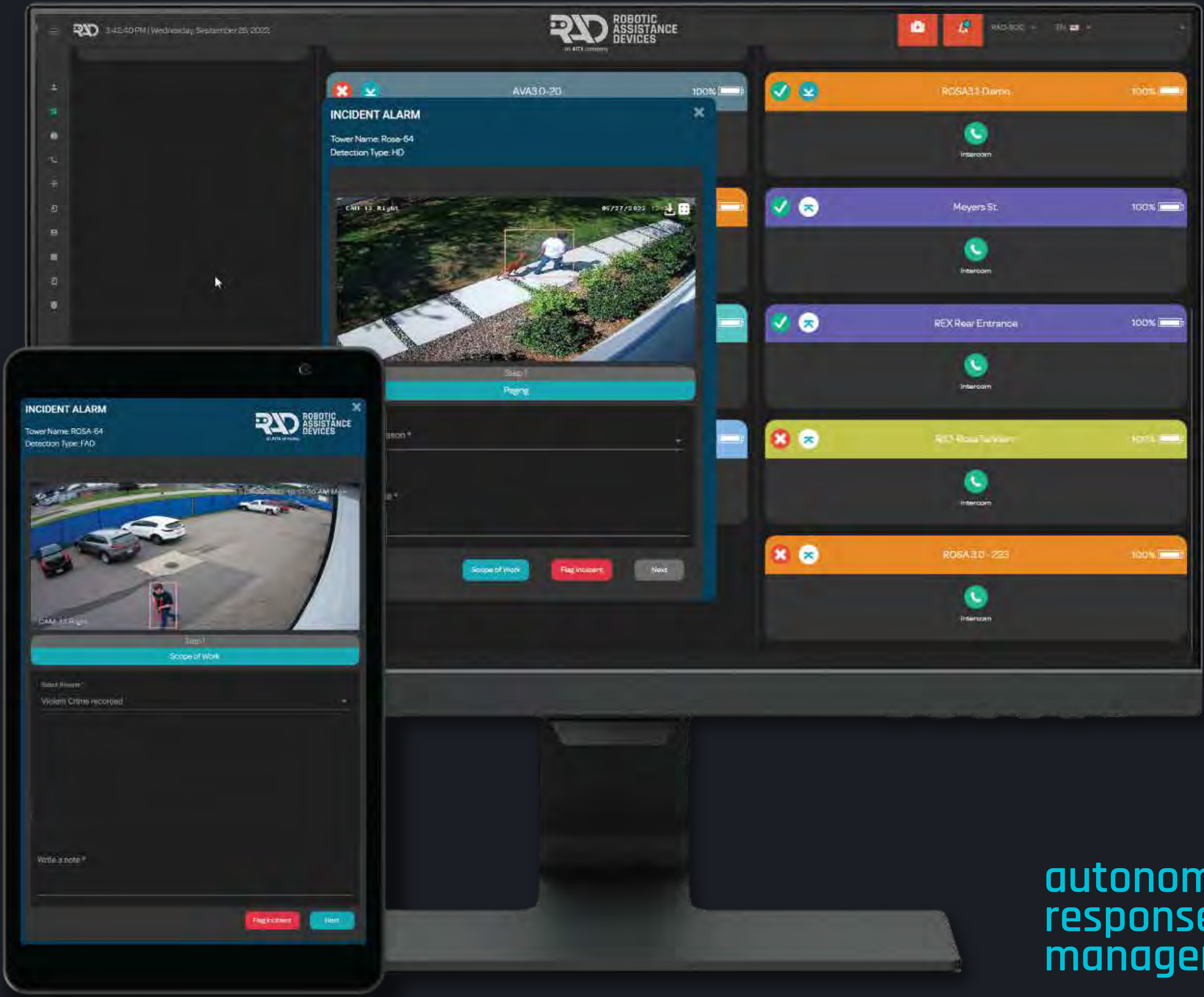

compare to
SureView™
and Immix™

integrate with
existing cameras

full multi-step
instructions with
timed reactions

central platform to
engage suspects

central platform to
activate accessories
(i.e. lockdown procedures)

full suite of
metrics

autonomous
response escalation
management

note: RAD device subscriptions include an unlimited number of user licenses to all software applications

RADMobile™ - Situational Awareness While On the Move!

real time
visibility



mobile
alerts

conveniently
initiate audio
'talk down'
through ROSA

note: RAD device subscriptions include an unlimited number of user licenses to all software applications



an AITX company

More security, less expense.
With RAD it's inevitable.

877-78-ROBOT

info@radsecurity.com • www.radsecurity.com

Details subject to change without notice. Copyright 2023, Robotic Assistance Devices, Inc.



available from



866-703-7666

www.aus.com